

WICKHAM

HARDWOOD FLOORING

DISCOVER OUR
COLLECTIONS



THE MOTHER OF ALL HARDWOOD FLOORS

Top-quality hardwood floors
made from Northern trees using
state-of-the-art technology:
That's the Wickham promise.



100% NORTH AMERICAN HARDWOOD

Wickham Hardwood Flooring is located in Wickham, Quebec (Canada). Active for more than 30 years in hardwood floor manufacturing, the company is entirely self-sufficient with its own kilns and processing plant including finishing lines. Renowned throughout Quebec and the rest of Canada, it also exports a significant portion of its production abroad, notably to the United States, Europe, Asia and the Middle East.

4 collections

FOR ALL TASTES & BUDGETS

If you are considering changing or upgrading your decor, you should choose Wickham Hardwood Flooring because we have what you are looking for. Pure and simple! Our unique, diverse collections offer a wide choice of options in terms of colors, widths, grades and finishes. If you want an exceptional, refined product that is both competitively priced and easy to work with, you'll find we have everything to meet your flooring needs.

CHOOSING WICKHAM HARDWOOD FLOORING MEANS CHOOSING

FROM A WIDE SELECTION

- 4 unique collections
- different platforms:
 - Solid
 - Engineered Baltic Birch Core (½" x ¾")

• 5 widths

Solid: 2 ¼ in. (58 mm), 3 ¼ in. (83 mm),
4 ¼ in. (108 mm), 5 in. (127 mm)
Engineered: 5 in. (127 mm),
7 in. (178 mm)

- 46 colors

• 7 species

Solid: ash, birch, hickory, maple,
silver maple, red oak, white oak

Engineered: red oak, maple, ash, white oak,

QUALITY

- Made exclusively from quality Northern Lumber •
Coated with premium finishes (7 coats)
- Precision-milled, subject to stringent quality controls and dried in state-of-the-art kilns
- Manufactured under optimal working conditions

RESPECT FOR OUR ENVIRONMENT





- Zero waste - all wood fibres are recycled
- Zero VOCs
- Carb2 compliant
- All our wood comes from sustainable sawmills

Wild West Collection

THE TRUE NATURE OF WOOD

Enjoy the true nature of wood with all its subtle nuances and warm patterns. Thanks to our wire brushing technique, each plank's texture and personality is revealed. The addition of unique tints conveys a classic or contemporary look. This collection offers an authentic and long-lasting floor that effectively hides scuffs and scratches.

SPECIFICATIONS

 SPECIES	Ash S E	Red Oak S E	White Oak S E		
 WIDTH	2¼ in. (58 mm) S	3¼ in. (83 mm) S	4¼ in. (108 mm) S	5 in. (127 mm) S E	7 in. (178 mm) E
 THICKNESS	½ in. (13 mm) E	⅞ in. (16 mm) E	¾ in. (19 mm) S E		
 GRADE	Select & Canadian Better Plus E S				
 FINISH	Matte 10° S E				

S Available in solid
E Available in engineered



AVAILABLE IN ALL COLORS*



* Not available in Barewood, Taupe and Naked

STRONG & BOLD



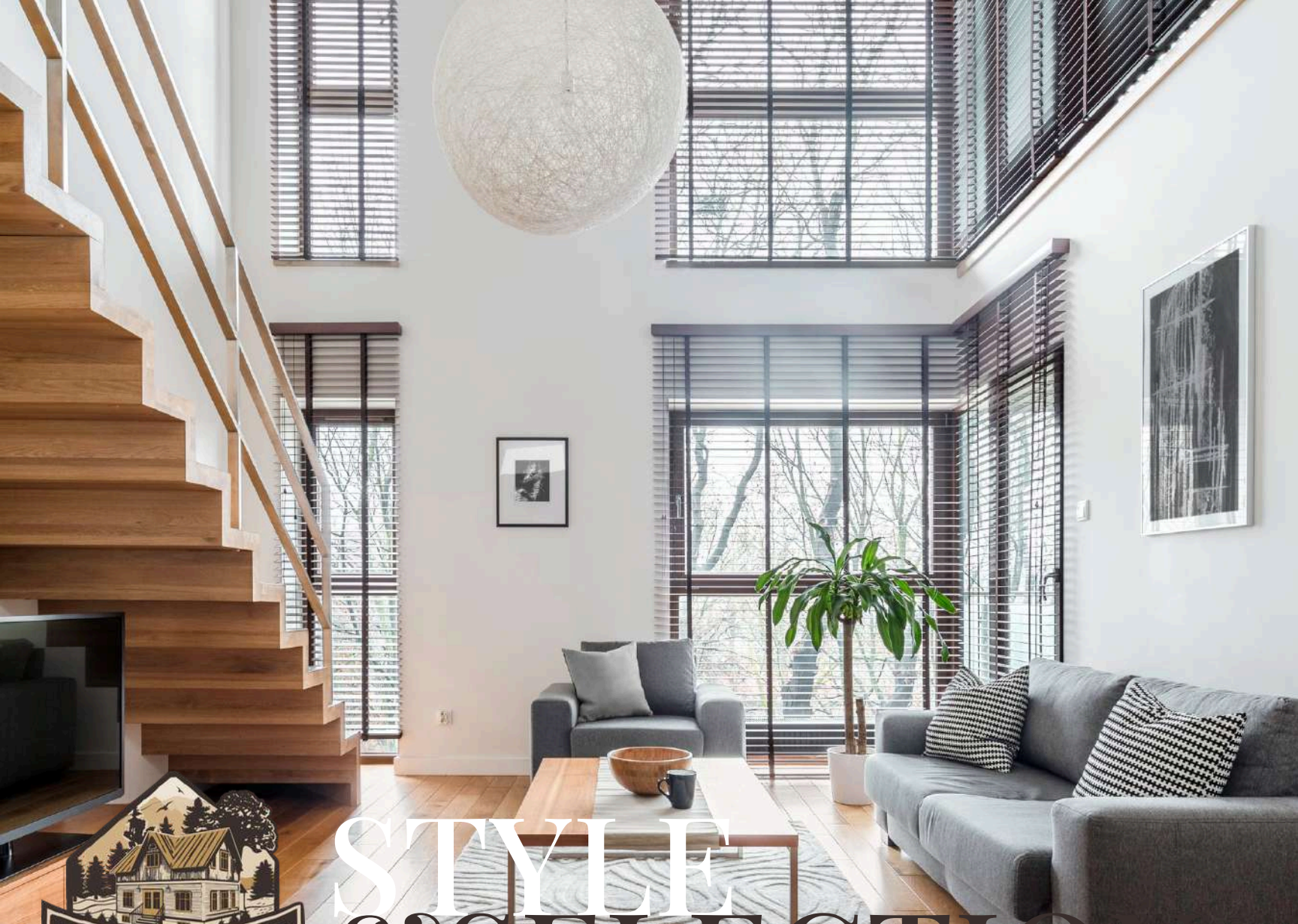

STYLE & SELECTION



STYLE & SELECTION

7 SPECIES AVAILABLE

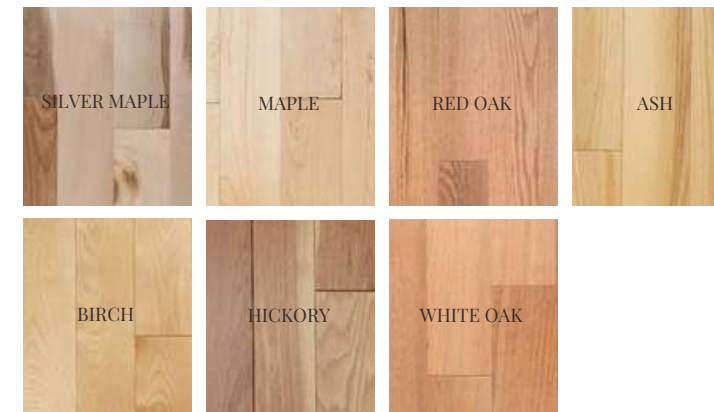

Domestic Collection

FIND YOUR STYLE

Nothing comes close to our Domestic Collection for helping you design your dream decor. Its flooring planks come in an unbeatable range of woods, colors and sizes. In addition, you can choose from five different grades, each with its own unique look. Whether you're aiming for a country or contemporary look, our vast collection has the flooring to suit your taste and design needs.

SPECIFICATIONS

SPECIES	Red Oak	Maple	Ash	Birch	
	S E	S E	S E	S	
	Hickory	White Oak	Silver Maple		
	S	S E	S E		
WIDTH	2 1/4 in. (58 mm)	3 1/4 in. (83 mm)	4 1/4 in. (108 mm)	5 in. (127 mm)	7 in. (178 mm)
	S	S	S	S E	E
THICKNESS	1/2 in. (13 mm)		3/4 in. (19 mm)		
	E		S E		
GRADE	Select Plus	Canadian	Builder	Cottage	
	E S	S	S	S E	
FINISH	Extra-Matte 5° 10°	Matte	Satin 35°	Semi-Gloss 55°	
	S E	S E	S E	S E	

S Available in solid

E Available in engineered

Domestic Collection

INFINITE POSSIBILITIES

Thanks to the wide variety of colors offered for each available wood, you can customize your floor and adjust it to your particular taste and decor for an original look that reflects your personality.

- 7 SPECIES
- 46 STANDARD COLORS
- 5 WIDTHS
- 4 GRADES
- 4 FINISHES

*The Hickory species is available in only 6 colors:
Natural, Cinnamon, Wheat, Copper, Haze, and Walnut.



AVAILABLE IN 46 STANDARD COLORS



WICKHAM HARDWOOD .COM











STYLE & SELECTION



Collection
Mountain Home

EACH PLANK, A MASTERPIECE.

The Mountain Home Collection stands out for its authentic aged wood appearance. Each plank is individually carved to create a unique floor. As a result, there may be a color variation of up to 10% between planks

SPECIFICATIONS

			
SPECIES	Birch	Red Oak	White Oak
	5 in. (127 mm)		
WIDTH			
	¾ in. (19 mm)		
THICKNESS			
	Cottage		
GRADE			
	Polyurethane-UV-cured: Matte 10		
FINISH			

 Offered in solid wood
 Offered in engineered wood

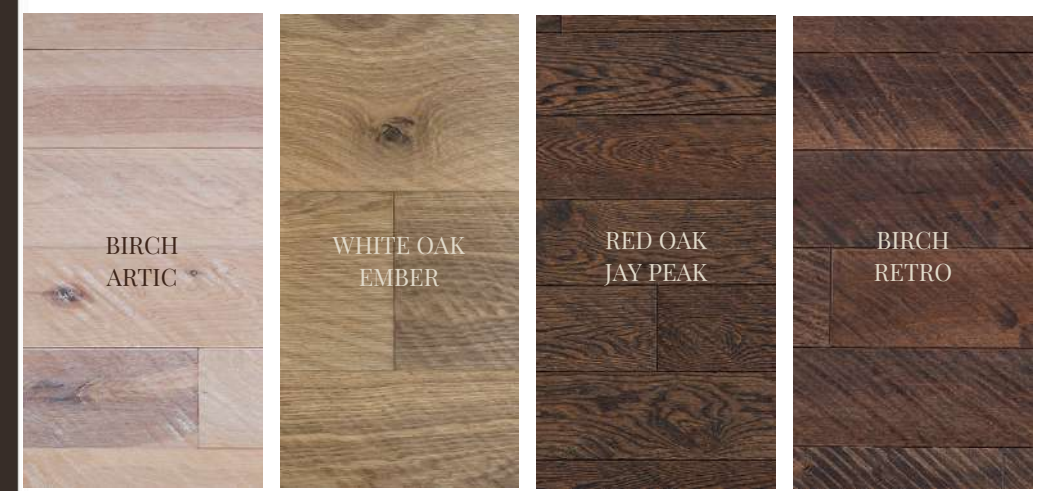

ARTISANAL & AUTHENTIQUE











ARTISANAL &
AUTHENTIQUE

Collection
Euro Engineered
**AUTHENTIC
EUROPEAN
OAK BEAUTY.**

In humid conditions, engineered flooring is more stable than solid hardwood. Ideal for condos and basements, it installs easily over concrete. The Euro Engineering collection offers the impeccable look and stability of European White Oak, meeting Wickham's highest standards.

SPECIFICATIONS

-  SPECIES White Oak
-  WIDTH 7 1/2 (190,05 mm)
-  THICKNESS 3/4 po (19 mm)
-  GRADE Select (AB) and Cottage (ABCD)
-  FINISH Polyurethane-UV-cured: 5 degree, Matte 10, satin 35, semi-gloss 55

-  Offered in solid wood
-  Offered in engineered wood

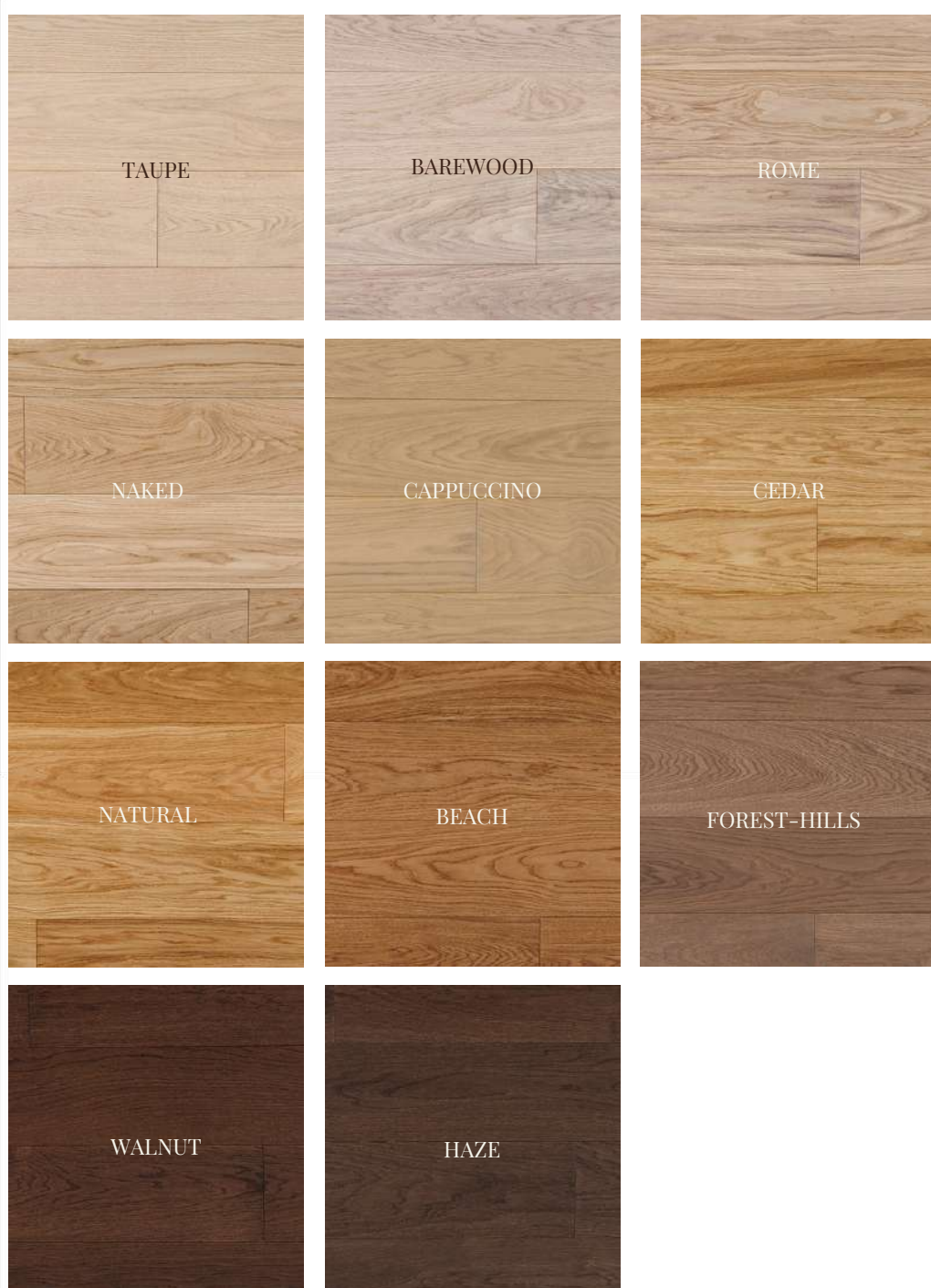

**STABILITY &
IMPECCABLE**



SPECIFICATIONS

	SOLID	ENGINEERED	
		ELITE ½ in. (13 mm)	ELITE PLUS ¾ in. (19 mm)
CONSTRUCTION	100% North American hardwood	100% North American hardwood / Baltic Birch core	
LENGTHS	12 in. (305 mm) to 84 in. (2,134 mm)	12 in. (305 mm) to 84 in. (2,134 mm)	
AVERAGE LENGTH	Depends on species, grade and width	32 in. (813 mm)	
THICKNESS	7/8 in. (19 mm)	½ in. (13 mm)	¾ in. (19 mm)
SQUARE FOOTAGE (PER BOX)	20 square feet for 2¾ in., 3¾ in. & 4¾ in. 21 squarefeet for 5 in	5 in. – 29 square feet	5 in. - 23 square feet 7 in. - 16 square feet
PLYWOOD	N.A.	7 ply – ¾ in. (9 mm)	11 ply - 9/16 in. (15 mm)
TOP LAYER	N.A.	5/32 in. (4 mm) Sliced top layer	
MATCH	Tongue-and-groove	Tongue-and-groove	
PROFILE	4 sides micro-beveled	4 sides micro-beveled	
INSTALLATION	Nailed/stapled	Glued, nailed/stapled, floated	
INSTALL APPLICATION	On, above	On, above or below grade	
SUBFLOOR	Wood	Wood, concrete, radiant heat*	
ACCESSOIRES AVAILABLE	Nosings, reducers, t-moldings	Nosings, reducers, t-moldings	
WARRANTY	35 years on residential finish. Lifetime structural.	35 years on residential finish. Lifetime structural.	

TABLE OF WOOD HARDNESS Values in pounds, as measured by the Janka test. The higher the number, the harder the wood

SPECIES	HARDNESS										
Birch	1,260										
Red oak	1,290										
Ash	1,320										
White Oak	1,360										
Maple	1,450										
Hickory	1,820										

*See manufacturer for approved system.



COMPARATIVE GUIDE

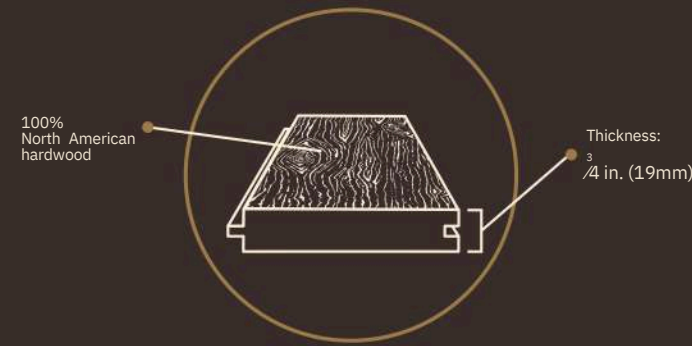

SOLID

Natural, warm and tough, hardwood floors offer exceptional durability, and all the elegance your personal style deserves. They also add to your home's resale value. What more could you ask for?

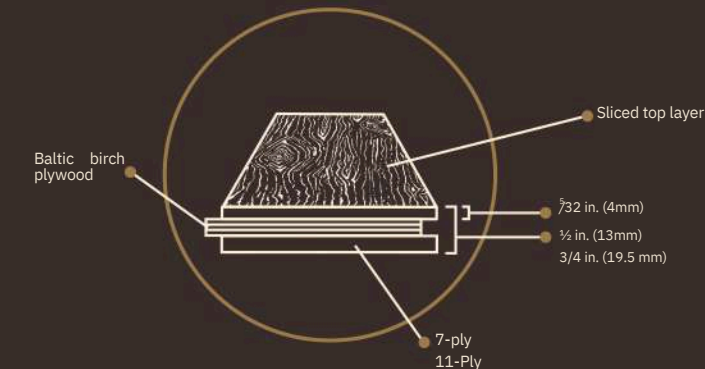

ENGINEERED BALTIC BIRCH

Under humid conditions, an engineered floor offers greater stability than a regular hardwood floor. And because it can be easily installed on concrete surfaces, it's the ideal choice for condominiums and basements. Made with a core of Baltic birch wood veneered with a 7/32 in. (4mm) layer of hardwood, this engineered floor meets Wickham's most rigorous standards.

GRADES

Every tree is unique, like a fingerprint, and every piece of wood is assigned a grade corresponding to its natural characteristics. This system is unequalled for proving wood's authenticity.

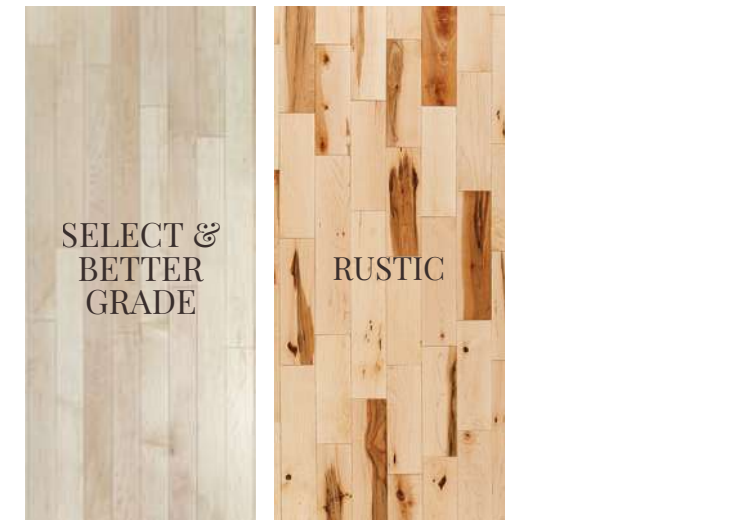

*For additional details, visit our website.



SUPERIOR QUALITY • CUTTING-EDGE TECHNOLOGY • EXCEPTIONAL DURABILITY

wickhamhardwood.com • Follow us 

1031, 7^e RANG, WICKHAM, QUEBEC, CANADA J0C 1S0 • 1 888 4 WICKHAM



| Proudly made in Canada

